

GST-IFP4M

Addressable Fire Alarm Control Panel







Features and Benefits

- 242 addressable devices per loop mixing various types of devices, Max. 1452 addresses
- Support up to 32 ZCP panel with individual programmable buttons & LED indicators. Max 8 ZCP panels for wall mount cabinet
- 7-inch Touch Screen 800 x 480
- Support 1-6 loops in Class A style (additional battery box is required for 5/6 loops)
- Wide range power supply
- Wall mount with glass door
- Built-in multiple languages, currently supports English, Spanish, Portuguese and Russian
- Programming via PC or panel keypad and touch screen
- USB port for system configuration and firmware update
- Password and key-protected nonvolatile memory
- Support USB dongle for securing project database
- History records of 100,000 events
- "Walk test", silent or audible
- PAS (Positive Alarm Sequence) per point
- Report device type mismatch and duplicated loop address
- Optional Redundancy CPU
- Built-in BACnet (Authorization code needs to be ordered separately)
- Optional Modbus Card
- Capability of remote downloading site specific data
- Compatibility with System Sensor's Bell (SSM24-6)
- Three colors for cabinet: Gray(default), White, Red.
- CAN/Fiber Networking, Panel grouping
- 2 Power Limited Class B Notification Appliance Circuits (NAC), total load Max.2.5A/24VDC. The 2nd NAC can be set as AUX.
- 1 Limit to non-monitored input interface

- 5 Form C relay outputs, including Alarm output, Trouble output, Supervisory output and 2 programmable outputs
- Built in printer and additional USB printer interface port for external printer
- Built in protocol to voice alarm system, communicate via onboard RS232 port

Compatible Devices

Detectors		I-9102(UL)/I-9103(UL) DI-M9101/DI-M9102/DI-M9103
Manual Call Point		DI-M9204
Modules		I-M9300/I-M9301 DI-M9300/DI-M9301/DI-M9305/ DI-M9319
Sounders & Strobes		DC-M9410 Synchronization Module DC-M9413R/DC-M9413W DC-M9414R/DC-M9414W DC-M9415R/DC-M9415W DC-M9416R/DC-M9416W
Loop Isolators		C-M9503 DC-M9503 DC-M9504

Terminals

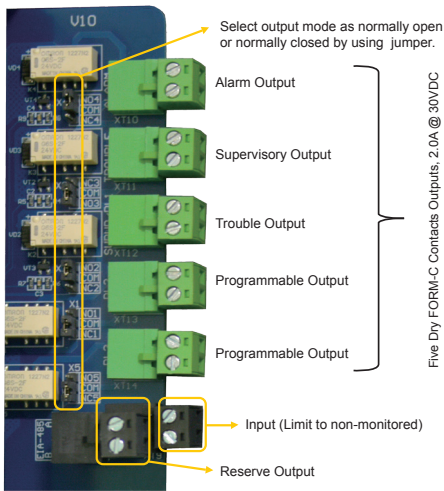

Five Dry FORM-C Contacts Outputs, 2.0A @ 30VDC

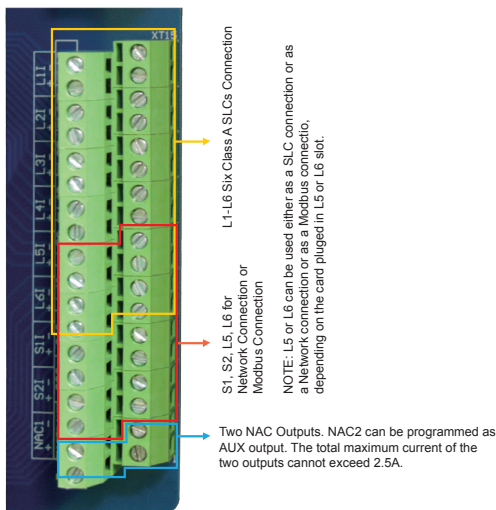

NOTE: L5 or L6 can be used either as a SLC connection or as a Network connection or as a Modbus connection, depending on the card plugged in L5 or L6 slot.

Fixed outputs:

Alarm output, Supervisory output, Trouble output
2.0A @ 30VDC, NO/NC can be set

Programmable outputs:

RL2, RL3
2.0A @ 30VDC, NO/NC can be set

EIA-485 port:

Reserved output port, not currently in use

Input port:

Limit to non-monitored input interface

Network ports:

S1 & S2 ports are reserved for network connection.
Relative CAN network card(s) is required.

NAC ports:

NAC1 & NAC2 NAC outputs connect Notification Appliances, Class B type.
Rated at 24VDC, total current cannot exceed 2.5A.
The NAC2 can be configured as AUX output, providing 24VDC for limited power consumption devices (4k7 EOLR for NAC, 1k EOLR for AUX).

Loop connections:

Panel supports maximum 6 loops, L1 ~ L6 ports link with corresponding slots.
Each loop is Class A type loop connection. Closed ring from LOOP OUT backs to LOOP IN.

Cable Requirement

- Loop: Minimum 18AWG, ideally 16AWG, 1300 meters
 - Network: Minimum 18AWG, ideally 16AWG, 3000 meters
 - Relay Output: Minimum 18AWG
 - NAC Outputs: Minimum 18AWG, ideally 16AWG
- All cables should be fire rated and follow local codes.**

Installation Data



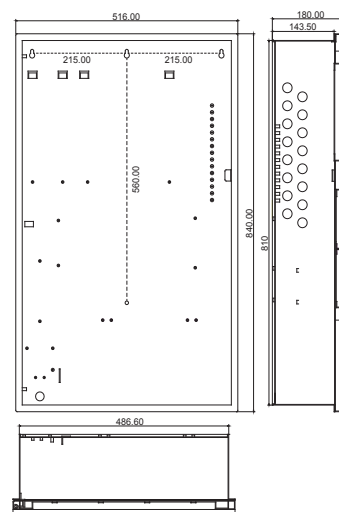









GST-IFP4M panel is wall-mount/flush-mount combined. Its appearance and the mounting holes are shown here.



Technical Specification

Primary Supply	120VAC / 60Hz, 220VAC / 50Hz
Max. Current	3.0A (120VAC) or 1.5A (220VAC)
Battery	Two 12V / 38Ah sealed lead-acid batteries
Max. Battery Capacity	Two 12V / 66Ah (additional battery box required)
Loop Capacity	1 - 6 Loops
Device Capacity	242 addresses per loop
Loop Parameter	Voltage: Nominal 24VDC Average current: 130mA Maximum alarm current: 200mA Maximum wiring resistance: 18ohms (each line)
NAC outputs	2 Notification Appliance Circuits Class B, Power-limited Output Voltage: Nominal 24VDC Max. Current: Totally 2.5A
Relay Outputs	3 fixed outputs 2 programmable outputs Rated 2A@30VDC
Input Rating	Maximum current: 1.7mA (short circuit)
Printer	Thermal, ASCII code printer
LCD Display	7" TFT touch screen, 800x480
Network Nodes	Max. 250 panels
PC Port	LAN/USB interface
Protection	IP30
Operating Environment	32-120° F (0-49°C) ≤93% RH, non-condensing
Dimensions	516mm(W) x 840mm(H) x 180mm(D)

Accessories and Tools

Image	Order Code	Part Number	Item Name
	4512716	CA-400-G	Panel Cabinet, Grey (default)
	4512717	CA-400-R	Panel Cabinet, Red
	4512838	CA-400-W	Panel Cabinet, White
	3600164	PR-400	Panel Printer
	3652720	P-9981	Zone Display Panel, Bi-color LED x40
	3652721	P-9981F	Zone Display Panel, R-LED x20, Y-LED x20
	3652722	P-9982	Zone Display & Control Panel, Bi-color LED x40, Button x20
	3652723	P-9982F	Zone Display & Control Panel, R-LED x20, Y-LED x20, Button x20
	3712727	NC-400	NAC Card
	3612858	MP-401	CPU Card
	3632729	LC-401	Single Loop Card
	3632730	LC-402	Dual Loop Card
	3672733	P-9956-Modbus	Modbus Card
	3662731	P-9966A	CAN Class A network card
	3662732	P-9983	Fiber-optical Network Card

Certificates and Compliance

- Standards: UL864 10th Edition / NFPA72
- Certifications: UL
- WEEE & RoHS Compliant

Order Information

Part No.	GST-IFP4M
Device Name	Addressable Fire Alarm Control Panel
Order Code	1005307